

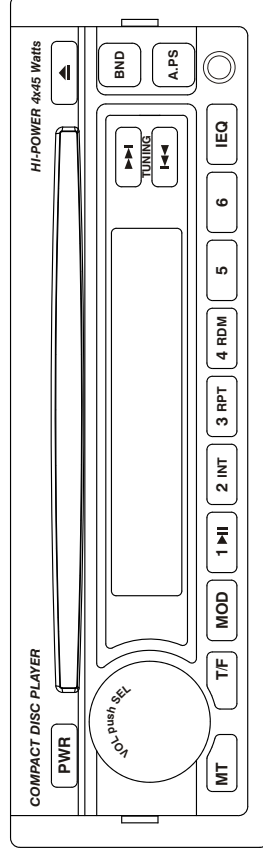

Operation Manual

for Users

Model No.: PP-106062



!!!!!!! ATTENTION !!!!!!!
THE RESET BUTTON MUST BE PRESSED
TO ENSURE PROPER OPERATION.
SEE INSTRUCTION MANUAL

PP-106062

Trouble shooting guide

INTERFERENCE ON RADIO
<ul style="list-style-type: none"> ▪ Poor atmospheric conditions - Try again later in the day. ▪ Antenna / lead broken or damaged.
DISTORTED AUDIO
<ul style="list-style-type: none"> ▪ Check loudspeaker wiring. This product contains a biamp. It is important not to connect the front loudspeaker ground to the rear speaker ground. ▪ Faulty loudspeaker. ▪ Distortion at highest volume levels may be normal, as amplifier has reached maximum power output. Otherwise the power and ground wire's gauge might be too small (use 10amp cable or more). ▪ Reduce the bass effect or switch off the loudness mode. ▪ Truck battery and or charging circuit may be faulty.

Specification

FM TUNER	AM TUNER
Tuning Range : 87.5~107.9MHz(USA) 87.5~108MHz (EUR) Sensitivity : 10dB / μ V Separation : 30dB	Tuning Range : 530~1710KHz (USA) 522~1620KHz (EUR) Sensitivity : 35dB / μ V
COMPACT DISC	AUDIO AMP & GENERAL
Freq. Response : 20 Hz-20 KHz Total Harmonic Distortion : 0.8% Signal - Noise Ratio : 65 dB Dynamic Range : 90 dB	Power Output : 4 x 45 watts Power Supply : DC + 12V Negative Ground Speaker Impedance: 4 ohm

1. Reset Function

A microprocessor reset function has been provided to facilitate manual resetting of the internal microprocessor. In the unlikely event that the player fails to operate correctly refer to step 3 below.

Note: It will be necessary to re-enter the radio preset memories as these will have been erased when the microprocessor was reset. After resetting the player, ensure all functions are operation correctly.

2. General Precautions

If the unit has become extremely hot we strongly recommend that you allow it to cool down before using. Take care of your CD DISC to preserve the quality of the recording. Do not allow CDs to be exposed to direct sunlight. Store them in a place protected from dirt and dust and avoid handling them with oily, greasy or wet hands. Be sure the CD is put into the CD slot label side up.

3. Caution

RESET: If you are faced with a malfunction during the operation, press and hold MODE and BAND button simultaneously for about 3 seconds to reset the unit.

Wiring Identification	2
Important Notes	3
Installation	4
Supporting the Unit	5
Identification of Control Functions	6
Controls	7
Operating the Radio	8-10
Operating the CD Player	11
Precaution and Maintenance	12
Trouble Shooting Guide & Specifications	13

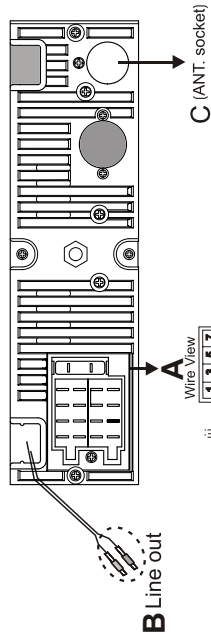

B Line out

Wire View



C (ANT. socket)

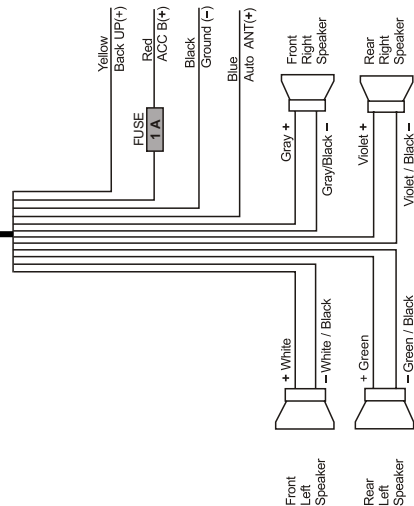

Front Left Speaker
Rear Left Speaker

Front Right Speaker
Rear Right Speaker

A: ISO CONNECTOR

SIDE A

1. Violet : Rear Right (+)
2. Violet/Black : Rear Right (-)
3. Gray : Front Right (+)
4. Gray/Black : Front Right (-)
5. White : Front Left (+)
6. White/Black : Front Left (-)
7. Green : Rear Left (+)
8. Green/Black : Rear Left (-)

SIDE B

4. Red : ACC B (+)
5. Dark Blue : Auto ANT (+)
7. Yellow : Back UP (+)
8. Black : GND (-)

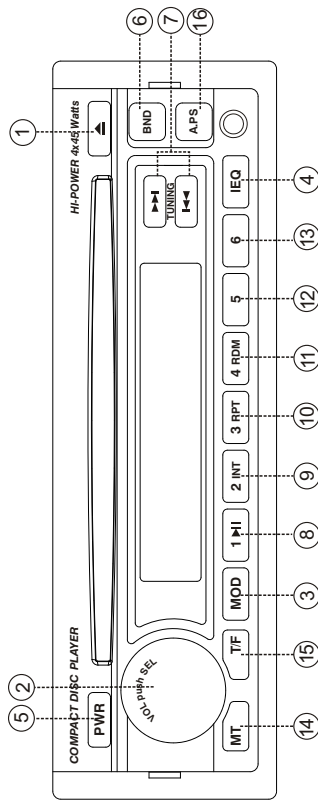

- 1.** Select the RADIO / CD / AUX by pressing the "MODE" button (3) in sequence.
- 2. Track tuning (7)**
Search the track on the DISC with $←$ & $→$ buttons. If you press $←$ or $→$ button continuously, the track goes fast forward or rewind.
- 3. Play / pause (8)**
Push to pause and push again to resume play.
- 4. Intro Scan (9)**
Press this button to hear the first 10 seconds of each track on the disc. Press this button again to restore the player to its normal play mode.
- 5. Repeat Play button (10)**
While playing a desired track, press the RPT button to play the track repeatedly. Press the RPT button again to return to normal play mode.
- 6. Random play button (11)**
Press the RDM button to play all tracks on a CD in random sequence. Press the RDM button again to return the player to normal mode.

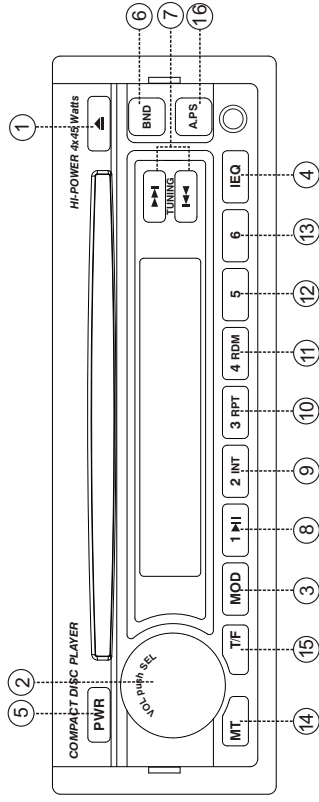

1. Press the **BND button (6)** to select the desired band FM1, FM2, FM3, AM1 or AM2.

2. **Manual / Seek tuning buttons (7)** : Press this button quickly to activate the Seek mode. The Seek mode will automatically seek up or down the wave band and stop at the next station of sufficient signal strength. Press this button (7) for longer than 2 seconds to advance the tuning up or down the wave band.

3. **Manual station store**: Select the desired band and tune to a radio station to be memorized. Choose the preset button memory location 1-6 into which the station is to be stored and press and hold that preset button for 2 seconds. The station will now be entered into the preset memory. 6 stations can be memorized on each of the FM1, FM2, FM3, AM1 & AM2.

4. **A.P.S - Auto store function. (16)**

Depress and hold button (16) for approximately 2 seconds until you hear a signal which confirms the memory function is complete and the display shows "SEARCH". Automatically six strong stations are stored on the station buttons 1 - 6. You can override the preset station on any button by manually setting a new frequency.

5. **Program memory scan**

Press the preset buttons 1-6 to find the memorized radio stations.

6. **Stereo - / mono - reception**

The unit is prepared for stereo reception as soon as it is turned on. If you now receive an FM-station which airs a stereo broadcast in the course of its program, the corresponding indication appears on the display.

Prior to the final installation, carry out a sound check. If high distortion or intermittent sound is experienced, it is possible that the wiring from the CD receiver to the truck's electrical system is poor or that the battery needs recharging.

If the battery and its charging circuit are OK, then rewire the red fused wire of the CD player directly to the positive terminal (+) of the truck battery.

Paccar Dealerships stock the connector blocks and the 10 Amp cable which may be necessary for extending the fuse wire connection.

■ **Grounding**

Make sure that the black wire on the wiring harness is connected to a good ground point on the truck. If the chassis of the Truck is used as a grounding point, make sure that the surface is scraped clean from the metal before attaching the wire to it.

It is preferable to connect the black ground wire directly to negative terminal (-) of the truck battery.

■ **Warning: polarity...**

This model is only suitable for use in trucks which have a negative ground system, e. g. : the negative terminal of the truck battery is connected to the chassis.

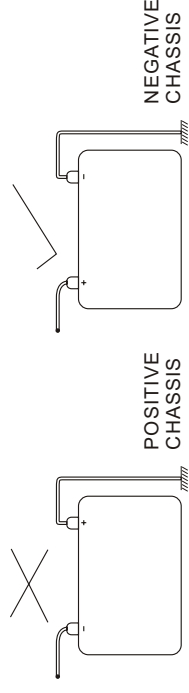

■ **Connecting the speakers and power cables**

Before you wire your system, disconnect your trucks battery's positive (+) cable. This helps prevent damage in case of a short. When you complete the wiring, reconnect the battery cable and test your new stereo. When connecting your stereo's black ground wire, be sure to connect the wire to a metal part of your truck or preferably to the negative (-) terminal of the truck battery.

1. Precautions

Choose the mounting location carefully so that the unit will not interfere with the normal driving functions of the truck.
 Avoid installing the unit where it would be subject to high temperature (such as from direct sunlight or hot air) or where it would be subject to dust, dirt or excessive vibration. Use only the supplied mounting hardware for a safe and secure installation.

2. Mounting angle adjustment

Adjust the mounting angle to less than 20 degrees from the horizontal position.

3. Mounting example

<< Installation in the cabinet >>

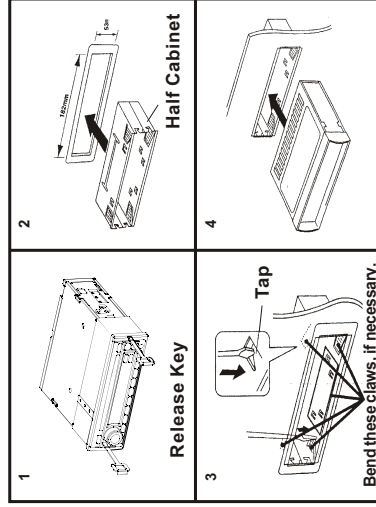

【Note】 Keep the release key in a safe place as you may need it in future to remove the unit from the truck.

6. IEQ button (4)

The IEQ feature creates a realistic atmosphere for the style of music you select using the latest digital sound technology.

Pressing this key repeatedly allows you to select from the following features :

- “FLAT” display - normal operation mode
- “CLASSICS” display - for the dramatic depth of classical music in an auditorium
- “POP” display - for the electric excitement of stadium pop
- “ROCK” display - for the subtle extension of the music’s dimensions
- “DSP OFF” display - cancel the sound feature

7. TIME/FREQUENCY (T/F) button(15)

- 1) After your unit has been installed in the truck, turn power on. The radio frequency will appear on the display.
 Press T/F button once to display time mode.
 Press T/F button once again (within 5 seconds) and hold until the displayed time Begins to blink.
- 3) Turn the spindle knob left to set the minutes.
- 4) Turn the spindle knob right to set the hour.
- 5) Once the adjustment is completed, press T/F button. The displayed time will stop blinking and within 5 seconds will revert to radio frequency.

8. MUTE button (14)

Press MUTE button(14) to mute sound. Press again to restore volume to original setting.

b. I-Vol

By pressing the button again, the unit will be into the I-VOL mode. (Initial Volume Level Adjustment). You can adjust the I-Vol of what you want to set by turning the spindle knob and the I-Vol will be set automatically. After the setting of initial levels, when the unit is power on/off, detach on/off, and ACC on/off, the I-VOL will keep the volume adjusted to the preset level when unit is turned on.

c. Area Selection

By pressing SEL button again, the unit will be in Area Selection mode. Use the spindle knob to choose USA or EUR (Europe). Press and hold the BAND button for 1-2 seconds to set the format.

3. Volume control

Turn the spindle knob (2) left or right to decrease or increase the volume level. Switching on your radio automatically allows you to set the volume level without having to select it first. Simply turn the spindle knob to set the desired level.

- Bass control

Turn left to lower the bass.

Turn right to increase the bass.

- Treble control

Turn left to lower the treble.

Turn right to increase the treble.

- Balance control

Turn left to decrease the right speaker volume.

Turn right to increase the left speaker volume.

- Fader control

Turn left to decrease the volume level of any loud speakers connected to the front channel.

Turn right to decrease the volume level of any loud speakers connected to the rear channel.

4. MODE Button(3)

Press this button to select radio, CD and AUX.

5. BAND function(6)

This button works 2 functions.

a. Shortly press the BAND button to select the desired band FM1, FM2, FM3, (AM).

b. In order to emphasize the bass and the treble at low volume, press and hold the BAND button for about 3 seconds. The display "LOUD" is indicated on the display.

To cancel loudness function, press and hold BAND again.

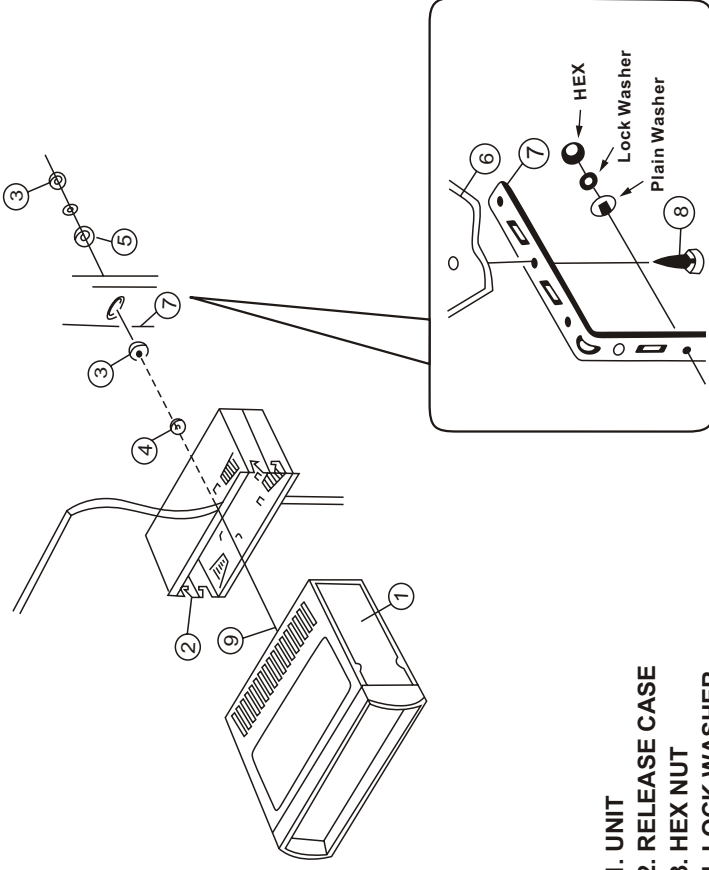

1. UNIT
2. RELEASE CASE
3. HEX NUT
4. LOCK WASHER
5. PLAIN WASHER
6. BODY
7. REAR SUPPORT STRAP
8. TAPPING SCREW
9. M5 X 20 HEX BOLT

■ Accessories subject to change without notice.

1. Fuse replacement

If the fuse blows, check the power connection and replace the fuse. If the fuse blows again after the replacement, there may be an internal malfunction. In this case, consult your nearest dealer.

2. Warning

Use the specified amperage fuse for each lead.
Use of a higher amperage fuse may cause serious damage.

Identification of Control Functions

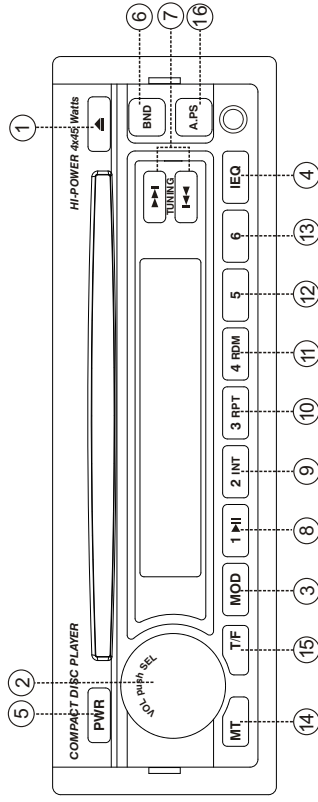

1. CD eject button
2. Electronic function SELECT button, Volume control knob
3. MOD button (Radio → CD → AUX IN)
4. IEQ button (FLAT - CLASSIC - POP - ROCK)
5. POWER ON/OFF button
6. Band button (FM1, FM2, FM3, AM1, AM2) / LOUD button
7. Radio tune UP/DOWN, CD track UP/DOWN
8. CD play / pause, radio preset 1 button
9. CD intro Scan button, radio preset 2 button
10. CD repeat track button, radio preset 3 button
11. CD random play button, radio preset 4 button
12. Radio preset 5 button
13. Radio preset 6 button
14. MUTE button
15. T/F(Time / Frequency) button
16. A.P.S - Auto Preset Scan button

Controls

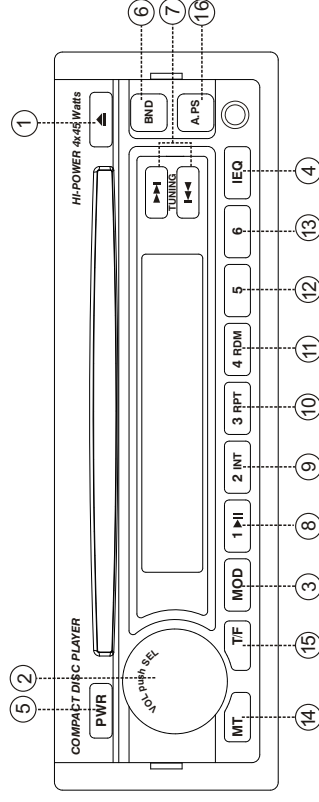

1. POWER ON/OFF

Push the button (5) to turn on the unit. Push the button again to turn off the unit.

2. SELECT Button (2)

1) Audio control (VOLUME / BASS / TREBLE / BALANCE / FADER)

Press key quickly to select the following features;

- "VOL" display - volume control > press key (2)>
- "BAS" display - bass tone control >press key (2)>
- "TRB" display - treble tone control > press key (2)>
- "BAL" display - balance control > press key (2)>
- "FAD" display - fader control > press key (2)>

If the key or one of the keys is not pressed within 5 seconds, the radio automatically switches into volume level control mode.

These settings are indicated on the display window.

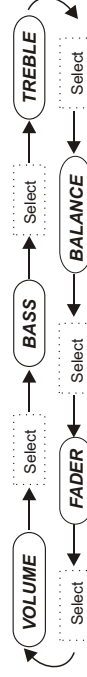

2) Beep 2nd, I-Vol, Area Selection

When the button is pressed over 2 seconds, the unit will be operated as below:



a. Beep 2nd

On the beep 2nd, you can control the beep on or beep 2nd by turning the spindle knob.

- Beep on : You can hear "beep" sound when you press all buttons.

- Beep 2nd : You can hear "beep" sound when you press the button over 1.5 secs.